

AURATON

R25 RT

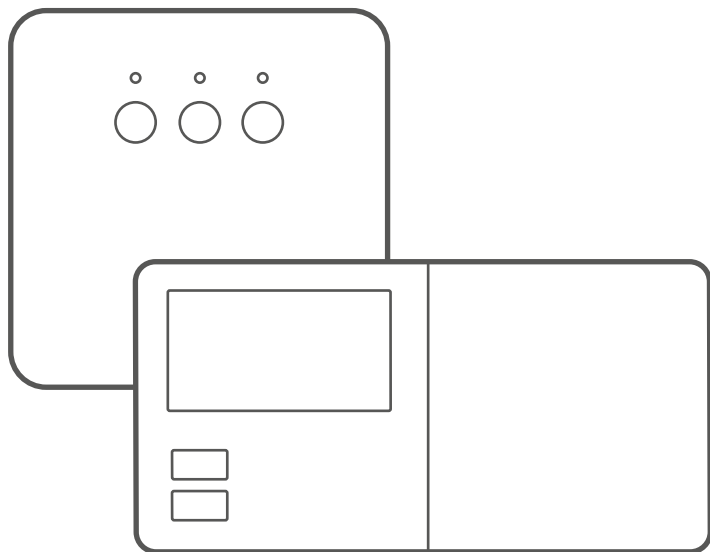

EN

OWNER'S MANUAL



www.auraton.pl

Thank you for purchasing this modern, advanced, microprocessor-based temperature regulator: **AURATON R25 RT**



4 independently settable temperatures

Day, night, anti-freeze, vacation.

16A

Operation under the load of up to 16A/10A

The AURATON RT receiver is equipped with a relay capable of operating with the load of up to 16A/10A. Its low-sparking technique of switching mains voltage contributes to the low wear of relay contacts.



Interference-free communication between devices

The transmitter and the receiver from the AURATON R25 RT set communicate at the frequency of 868 MHz. Very short, encrypted data transmission packets (approx. 0.004 s) ensure very efficient and interference-free operation of the device.

LCD

Backlit LCD display

The backlit LCD display allows for supervising operation of the device even in a poorly lit room. (3 selectable backlight colours)

Optional elements of the system



AURATON H-1

Window handle (sold separately)

A window handle, equipped with a position sensor and a transmitter, is an optional element of the system. This way the handle provides information about the state of the window. The handle also differentiates between 4 window positions: opened, closed, pivoted and trickle ventilated (micro-ventilation). The handle transmits information to the RT receiver that controls the relay, e.g. switching off a heater in the event of opening the window or lowering the temperature down to 3°C to conserve energy. One RT receiver operates with max 25 handles.

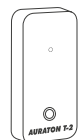

AURATON T-2

Thermometer (sold separately)

An optional element of the system allowing for controlling temperature in a room other than that with the AURATON R25 RT regulator.

Description of the AURATON RT receiver

The AURATON RT receiver works with the wireless AURATON R25 RT controller. The receiver is installed near the heating or air conditioning device and may work with the load of 16A/10A.

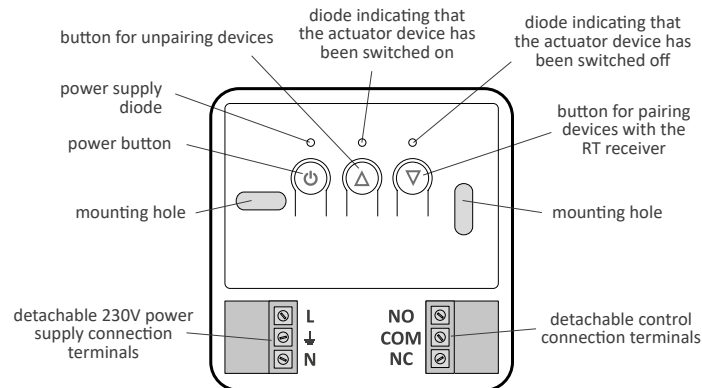

Legend - description of LED signalling

- The LED light's green** – the output device is off (the contacts COM and NC are closed).
- The LED light's red** – the output device is on (the contacts COM and NO are closed).
- The LED flashes green** – the RT receiver awaits the device to be paired (*chapter: "Pairing the AURATON R25 RT wireless regulator and the RT receiver"*).
- The LED flashes red** – the RT receiver awaits the device to be deregistered (*chapter: "Deregistering the regulator from the RT receiver"*).
- The LED flashes alternating red and green:**
 - ALARM** - the RT receiver has lost connection with one of the paired devices (*chapter "Special situations"*).
 - RESET** - receiver deregisters all previously paired devices (*chapter "Deregistering all devices paired with the RT receiver"*).
- Green power supply diode** – the RT receiver is switched on.

Description of temperature regulator

On the right side of the front panel of the regulator you will find a sliding cover. There are buttons under the cover. You can easily remove the cover in order to replace batteries.

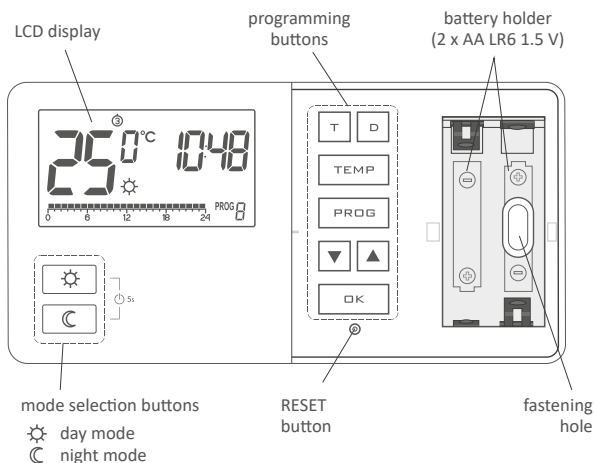

Display

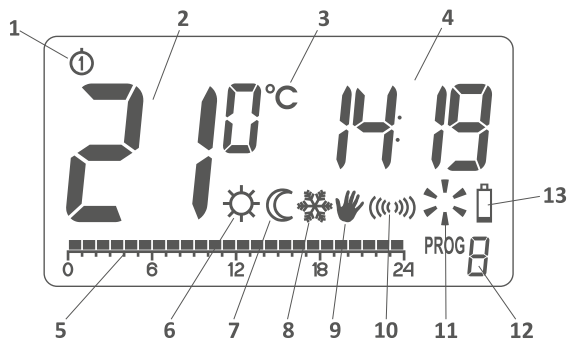

1. Day of the week

Indicates the current day of the week. Every day is assigned a number.

2. Temperature

In the normal mode of operation, the regulator displays the temperature in the room it is installed in.

3. Temperature unit

Informs whether the temperature is displayed in degrees Celsius (°C)

4. Clock

Time is displayed in the 24-hours format.

5. Time line

A program progress indicator. It is a line divided into 24 sections. Each section corresponds to one hour. This line shows how a given program will be executed. (See chapter: "Time line")

6. Day mode indicator (☀)

Indicates that at the moment, the regulator operates in day mode. (See chapter: "Temperature programming")

7. Night mode indicator (☾)

Indicates that at the moment, the regulator operates in night mode. (See chapter: "Temperature programming")

8. Anti-freeze mode indicator (❄)

Indicates that at the moment, the regulator operates in anti-freeze mode. (See chapters: "Temperature programming" and "Anti-freeze mode")

9. Manual control indicator (✋)

Appears when you temporarily leave the mode of operation of the programmed mode. (See chapters: "Manual control" and "Vacation mode")

10. Transmission symbol (📶)

Indicates ongoing communication with the RT receiver.

11. Regulator power-on symbol (🌀)

Spinning fan informs about the state of operation of a controlled device and is visible only when the device is switched on (boiler, heater etc.).

12. Program number

The number of the currently executed program is displayed. (See chapters: "Factory programs" and "Week-wise programming")

13. Low battery (🔋)

This indicator will be visible when the battery voltage drops to the minimal allowable level. In such an event, replace the batteries as soon as possible.

NOTE: In order to preserve the programmed parameters, the duration of the replacement operation must not to exceed 30 seconds.

Selecting the proper location for temperature regulator

Proper operation of the regulator is greatly affected by its location. Installing it in a place with no air circulation or exposed to direct sunlight causes improper regulation of temperature. In order to ensure proper operation, the regulator must be installed on an interior wall of a building (partition wall). A place should be selected that is occupied most frequently, providing undisturbed circulation of air. Avoid heat radiating devices (television set, heater, refrigerator etc.) or places exposed to direct sunlight. In order to avoid vibration, do not place the regulator in close vicinity of doors.

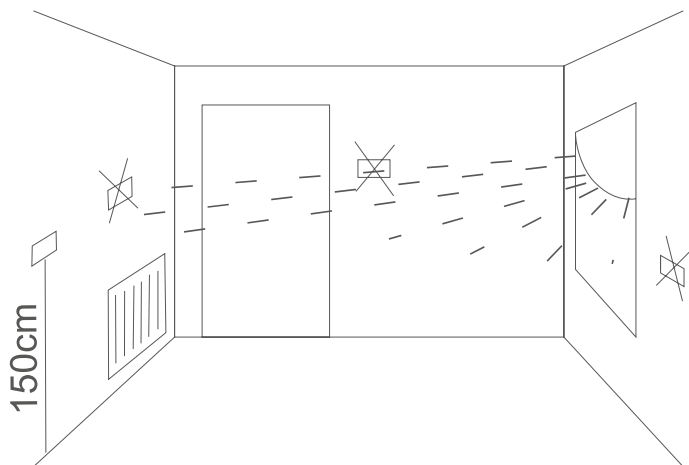

Fastening the temperature regulator to the wall

1. Drill two holes 6 mm in diameter in the wall (use the template attached to the manual to mark the spacing between these holes).
2. Insert plastic wall plugs (included in the kit).
3. Screw in the left screw with a 3 mm clearance.
4. Put the regulator over the screw head and slide it to the left (pay attention to the key-hole in the rear wall of the regulator).

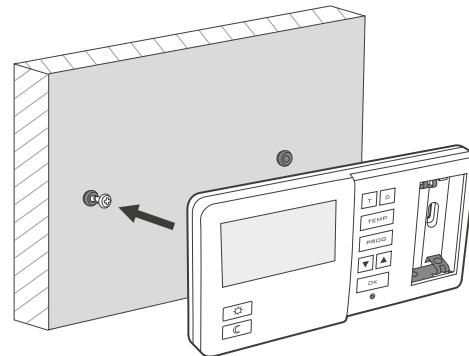

5. Screw in the right screw, making sure it holds the regulator securely.

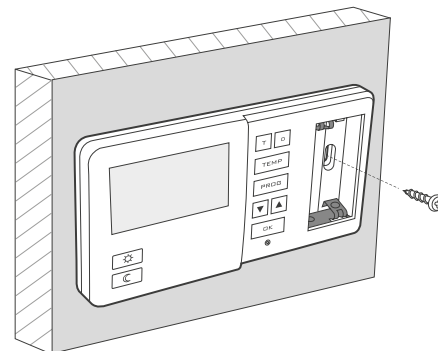

NOTE: If the wall is wooden, there is no need to use wall plugs. In such a case, drill two holes 2.7 mm in diameter instead of 6 mm, and screw the screws directly into the wood.

Installation of the AURATON RT receiver

CAUTION! The cables delivered in a set together with the controller are suitable for maximum loads equal to 2.5 A. If devices with higher power are connected, the cables should be replaced with ones of appropriate cross-sections.

NOTE: When installing an AURATON RT receiver, make sure that the power supply is switched off. The receiver should be installed by a professional.

NOTE: In the permanent system of the building there must be a switch and an overcurrent protection.

NOTE: In order to facilitate installation, the terminals are fitted with extendable clamps. Before cable connections are made, they can be disconnected from the controllers. The cables may be routed from the bottom of the receiver by breaking out holes in the mounting cover or from the back of the receiver if the cables are extended from the wall. In order to connect the cables from the back, the cover must be broken out.

1. Take off the cover of the front part of the AURATON RT receiver by unscrewing the screws half way out.

2. Connect the heating device to the terminals of the control connection of the AURATON RT receiver. Follow the service instruction of the heating device. The COM (common) and NO (normally opened) terminals are used the most often.

3. Connect the power supply cables to the terminals of the power supply connection of the AURATON RT receiver, in observance of safety rules.

4. After the cables are connected, they must be fixed with the "cable fastening holder" and the covers must be screwed back to the AURATON RT receiver.

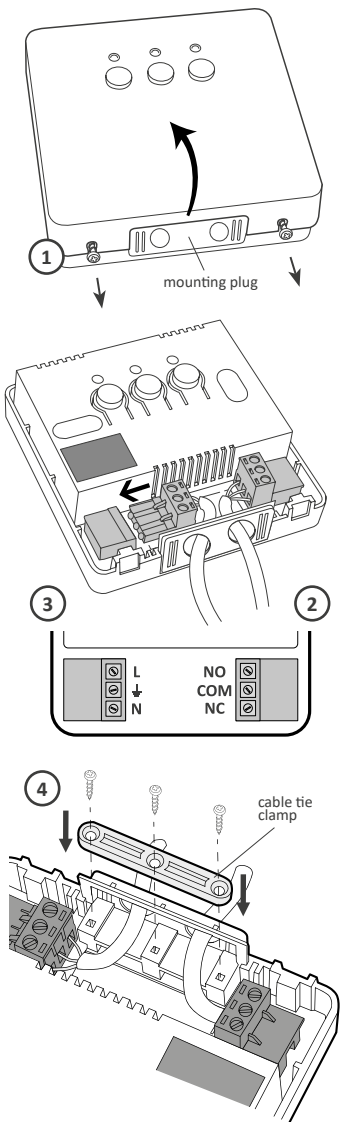

Fastening the AURATON RT receiver to a wall

In order to fasten the AURATON RT receiver on a wall:

1. Take off the covers from the front part of the controller (see chapter "Installation of the AURATON RT receiver").
2. Mark the location of the holes for the fastening screws on the wall.
3. In the marked locations, drill holes with diameters appropriate for the diameters of the enclosed wall plugs (5 mm).
4. Put the wall plugs in the drilled holes.
5. Fasten the AURATON RT receiver to the wall using screws so that the receiver is well fastened.

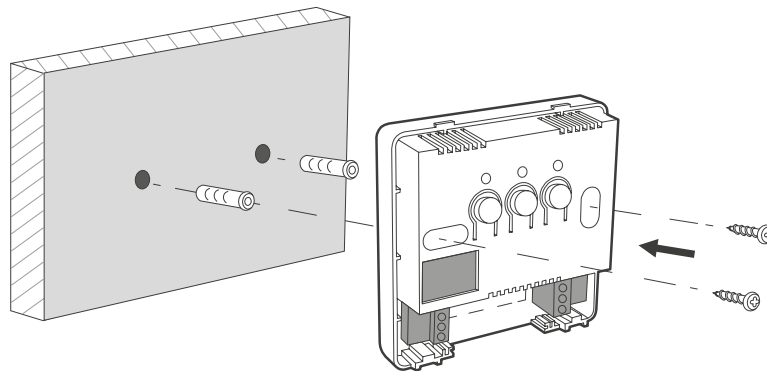

NOTE: If the wall is wooden, there is no need to use wall plugs. In such a case, drill two holes 2.7 mm in diameter instead of 5 mm, and screw the screws directly into the wood.

NOTE: The RT receiver cannot be placed in metal containers (e.g. an assembly box, a metal enclosure of a heater) in order to not to interfere with its operation.



Pairing of the wireless AURATON R25 RT controller with the AURATON RT receiver

After the receiver is connected to the network, the receiver must be switched on by quickly pressing the power button (). If the device is switched on, the green power supply diode becomes illuminated and a single sound signal is emitted. In order to switch off the receiver, e.g. outside of the heating season, press the power button and hold it for 3 seconds until a double sound signal is audible and the green power supply diode is switched off and, consequently, the heating device is switched off.

NOTE: If the wireless controller AURATON R25 RT is sold together with the AURATON RT receiver, the two devices are factory-paired. Devices purchased separately must be paired.

1. Pairing of the AURATON R25 RT controller with the AURATON RT receiver is initiated by pressing the right pairing button (green triangle ) - a single sound signal is emitted - on the AURATON RT receiver and by holding it pressed for at least 3 s until the LED diode starts blinking with green light (double sound signal) - then the button must be released.

The AURATON RT receiver waits for pairing for 120 seconds. After this period, it automatically returns to normal operation.

2. On the AURATON R25 RT, the  button must be pressed for 5 seconds until the transmission symbol () is illuminated on the display. Release the button - the controller emits the pairing signal for 5 seconds.
3. Successful end of pairing is indicated by the LED diode on the AURATON RT receiver no longer blinking green, emission of a single sound signal, and the receiver switching to normal operation.



In the event of a pairing error, steps 1 and 2 must be repeated. If more errors occur, all devices must be unpaired by RESETTING the AURATON RT receiver (see „RESET - Unpairing all devices paired with the AURATON RT receiver“) and then an attempt must be made to pair the devices again.

NOTE: Only 1 temperature controller may be paired with one receiver.

Unpairing of the controller and the RT receiver



1. Unpairing of the AURATON R25 RT controller from the AURATON RT receiver is initiated by pressing the left unpairing button (red triangle - ) on the receiver and holding it for at least 3 seconds until the LED diode starts blinking red - then the button must be released. The sound signal works in the same way as during pairing, i.e. when a button is pressed, a short sound is emitted and another short sound signal after 3 seconds.

The AURATON RT receiver waits for unpairing of the device for 120 seconds. After this period, it automatically returns to normal operation.

2. On the AURATON R25 RT, the  button must be pressed for 5 seconds until the transmission symbol () is illuminated on the display. Release the button.
3. Successful unpairing is indicated by the LED diode on the AURATON RT receiver no longer blinking red, emission of a single sound signal, and the receiver switching to normal operation.

In the event of an unpairing error, steps 1 and 2 must be repeated. If more errors occur, all devices must be unpaired (see „RESET - Unpairing all devices paired with the AURATON RT receiver“).

RESET - Unpairing all devices paired with the AURATON RT receiver

In order to unpair all devices paired with the AURATON RT receiver, simultaneously press and hold both the pairing and the unpairing button ( and ) for at least 5 seconds, until the LED diode starts blinking green and red alternately. Then release both buttons. Sound signal: when the button is pressed, a short sound signal is emitted, followed by another short signal 5 seconds later.

Successful completion of unpairing of all devices is signaled after about 2 seconds by the diode color changing to green and then switching off for a short time.

NOTE: If the power supply of the AURATON RT receiver is switched off and then switched on after the RESET, the receiver automatically goes into the “pairing” mode for 120 seconds. A newly purchased (separately from the controller) AURATON RT receiver acts in the same way if it has no factory-paired devices.

Signaling of operation and receipt of data packets

Each reception of radio transmission from a paired device is indicated by the AURATON RT receiver by a momentary change of the color of the LED diodes. After the relay becomes activated, the LED diode is red and after it is switched off - it is green.

NOTE: When any button is pressed, a short sound signal is emitted.

Starting-up the regulator for the first time

After the proper placement of batteries in the battery holder, all segments of the LCD display are displayed (display test) for one second; during the next second, the software version number is displayed.

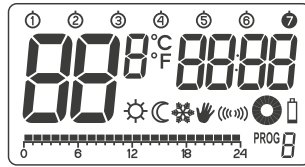

Following that, the regulator enters time setting mode; the hour field flashes, prompting for setting it.

Using the \blacktriangledown and \blacktriangle buttons, set the desired hour value and confirm the setting with the \square OK button.



The regulator switches to setting minutes.

Using the \blacktriangledown and \blacktriangle buttons, set the desired minute value and confirm the setting with the \square OK button.



In the upper part of the display, the day of the week symbol starts flashing.

Using the \blacktriangledown and \blacktriangle buttons, set the desired day of the week and confirm the setting with the \square OK button.

The regulator enters its normal mode of operation.

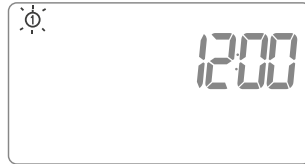

NOTE:

If no button is pressed in 60 seconds when setting the hour value for the first time, the regulator will automatically enter its normal mode of operation.

NOTE:

When programming any other functions, failing to press any buttons in 10 seconds is equivalent to pressing the \square OK button.

Setting the clock

In order to set the clock:

1. Press the \square T button. The hour field starts flashing, prompting for setting it.
2. Using the \blacktriangledown and \blacktriangle buttons, set the desired hour value.
3. Then press the \square T button again. The minute field starts flashing, prompting for setting it.
4. Using the \blacktriangledown and \blacktriangle buttons, set the desired minute value.
5. Confirm the setting with the \square OK button.

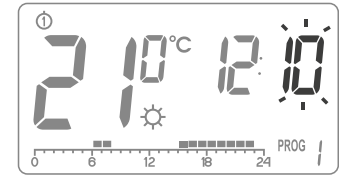
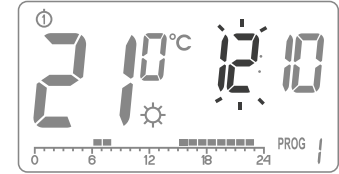

Setting the day of week $\textcircled{1}$... $\textcircled{7}$

In order to set the day of week:

1. Press the \square button. One of the digits representing days of the week starts flashing, prompting for setting it.
2. Using the \blacktriangledown and \blacktriangle buttons, set the desired day of week.
3. Confirm the setting with the \square OK button.

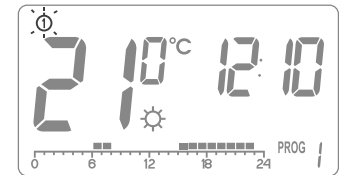

LO, HI indicator

- If measured temperature is lower than 5°C LCD will display „LO“.
- If measured temperature is higher than 30°C LCD will display „HI“.



Default settings of programs

- **Monday – Friday:**
The heating device maintains day temperature from 05:00 to 08:00 and from 15:00 to 23:00.
- **Saturday – Sunday**
The heating device maintains day temperature from 06:00 to 23:00.
- **Default temperature setpoints:**
 - ☼ Day temperature – 21,0°C
 - ☾ Night temperature – 19,0°C
 - ❄ Anti-freeze temperature – 7,0°C

Programming the day (☼), night (☾) and anti-freeze (❄) temperatures

The R25 RT regulator allows for programming 3 kinds of temperatures:

- Day temperature (☼) - from 5 to 30°C
- Night temperature (☾) - from 5 to 30°C
- Antifreeze temperature (❄) - from 4 to 10°C

In order to set one of the above temperatures:

1. Press the **TEMP** button.
2. The current temperature setpoint will appear on the display with the symbol:
 - ☼ – day temperature,
 - ☾ – night temperature,
 - ❄ – anti-freeze temperature.
3. Using the **▼** **▲** buttons, set the desired temperature setpoint.
4. By pressing the **TEMP** button, toggle between the available kinds of temperature to be set (☼ , ☾ , ❄);
5. After setting all 3 temperature setpoints, confirm the setting with the **OK** button.



NOTE: The value of the night temperature setpoint can be equal to or lower than the value of the day temperature setpoint. It is not possible to set the night temperature setpoint higher than the day temperature setpoint.

INTRODUCTION TO PROGRAMMING

Time line

The LCD display displays the time line divided into 24 sections, where each section corresponds to 1 hour of a 24-hour long day.

A black rectangle above a given hour indicates that the day temperature is maintained, whereas no such a rectangle indicates that the night temperature is maintained.

An example:



The above picture shows that from 06:00 to 23:00 the regulator controls the heating device in a manner to maintain the day temperature in the room (☼). From 23:00 to 06:00 the regulator switches over to the night temperature (☾).

Factory programs

In order to let the regulator know when to use the day or the night temperature, it is necessary to assign an appropriate program to each day of week. In order to do this, you can use one of the three factory-defined programs:

Program no. 0 – anti-freezing ❄

A factory program designed for setting the anti-freezing temperature. Selecting this program causes the maintaining of the anti-freezing temperature throughout the day.

Program no. 1 – week days

A factory program that cannot be modified. Setting this program causes the heating devices to maintain the day temperature from 05:00 to 08:00 and from 15:00 to 23:00.

Program no. 2 – weekend

A factory program that cannot be modified. Setting this program causes the heating device to maintain the day temperature from 06:00 to 23:00.

Program no. 3, 4, ..., 9 – user defined

Programs no. 3 through 9 are user-defined programs. The user can modify and adapt them at will.

PROGRAMMING

Weekly programming

In order to program the regulator, it is necessary to decide on which day of the week and during what period of time the day temperature should be maintained. During the remaining time, the night temperature will be maintained.

An exemplary mode of operation of the regulator from Monday until Sunday. Besides the defined periods of time, the regulator maintains the lower night temperature.

Day of week	Day temperature
Monday	5:00 – 8:00; 15:00 – 23:00
Tuesday	5:00 – 8:00; 15:00 – 23:00
Wednesday	5:00 – 8:00; 15:00 – 23:00
Thursday	5:00 – 8:00; 15:00 – 23:00
Friday	5:00 – 8:00; 15:00 – 23:00
Saturday	8:00 – 23:00
Sunday	8:00 – 23:00

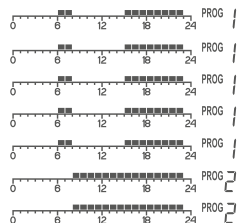

SELECTING A PROGRAM

In order to select a program:

1. Press the **PROG** button. The program description field starts flashing.
2. Press the **□** button. Using the **▼▲** buttons or the **□** button set the day of the week when the program should be executed.
3. Pressing the **PROG** button several times, select the desired program number. Programs no. 0-2 are factory-defined and programs no. 3-9 can be modified.
4. Confirm the setting with the **OK** button.
5. Return to step 1 and repeat the above procedure for the next day of the week. Programming can end when each day of week is assigned an appropriate program.

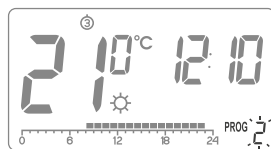
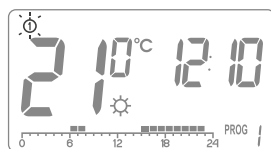
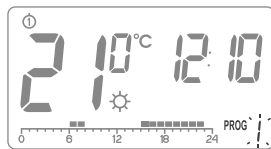

MODIFYING A USER-DEFINED PROGRAM (prog. 3...9)

In order to modify a program:

1. Press the **PROG** button. The program description field starts flashing.
2. Press the **□** button. Using the **▼▲** buttons or the **□** button, set the day of the week when the program should be executed.
3. Pressing the **PROG** button several times, select programs number 3-9 (user-defined)
4. All (24) rectangles will be lit on the time line. One rectangle corresponds to one hour. If a rectangle is visible, the day temperature will be maintained during the corresponding hour. A turned off rectangle indicates that the night temperature will be maintained. In the picture, the first rectangle flashes - a flashing rectangle indicates the point on the time line where the change is being made.
5. Pressing the **☀** or **☾** button, select the day temperature (visible rectangle) or the night temperature (turned off rectangle).
6. Using the **▼▲** buttons, highlight consecutive hours on the time line, and for each hour select the day or night temperature (a currently selected rectangle is turned on or off with the **☀** or **☾** button, respectively).
7. Having modified the entire time line, save the program with the **OK** button.

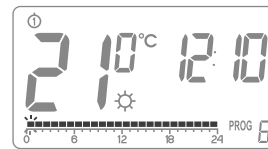
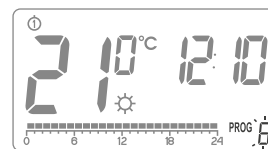
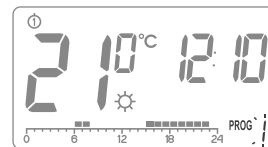





NOTE:



Once modified, the program can be assigned to other days of the week by selecting it for that day.

Manual control

When, for any reason, you would like to suspend execution of the program for a certain period of time, e.g. due to a party when you want to maintain the day temperature until the end of the party, and the regulator has already started decreasing the temperature down to the night temperature setpoint ("C" is displayed), perform the following steps:

1. Press the  button. The "  " will appear on the display. A comfortable temperature will be maintained until the next temperature change performed by the program.
2. In order to cancel the above mentioned function, press the  button located under the battery cover; the "  " symbol will disappear.









Similarly, if the program at the moment maintains the day temperature and you leave your home for a longer period of time, then:

1. Press the  button. The "  " will appear on the display. The night temperature will be maintained until the next temperature change performed by the program.
2. In order to cancel the above mentioned function, press the  button.

Vacation mode

There are times when we leave our homes for a longer time. In order to avoid re-programming the entire regulator, vacation mode can be used. This mode makes the regulator to maintain just one temperature during the entire period of your absence. It can last for as short as 1 hour, and as long as 99 days.

In order to enter vacation mode:

1. Press the  or  button and hold it for 3 seconds. The display shows the temperature and the flashing time field. Use this field to set the duration for the vacation mode.
2. Using the   buttons, set time: hours (1-23) and then days (1-99). Confirm the setting with the  button.
3. The temperature field starts flashing. Using the   buttons, set the temperature. Confirm the setting with the  button.

If the selection is not confirmed within 10 seconds, the regulator will automatically enter vacation mode.

In order to leave vacation mode, press the  button.

NOTE: The vacation temperature is independent of the day, night or anti-freezing temperature.

Setting the anti-freezing temperature program

The AURATON R25 RT regulator is equipped with a setpoint for the anti-freeze temperature. This setpoint can be set within the range from 4 to 10°C. (Factory set at 7°C)

The anti-freezing temperature setpoint is used during a prolonged absence or outside the heating season and is designed to prevent water in the heating system from freezing. In order to set the anti-freezing temperature program, select the program **no. 0** for each day of week. (See chapter: "Weekly programming - selecting a program")

Heating device run time counter



The AURATON R25 RT regulator is equipped with a function for counting the run time of the heating device. The function is activated by pressing the  button and holding it for 5 seconds.



The display will show information about the accumulated run time since the last reset of the device.

NOTE: The run time counter counts the time between sending the "switch on the heating device" signal (displaying the "fan" symbol) and sending the "switch off the heating device" signal. This time can vary from the actual run time of the heating device, e.g. due to the fact of using internal thermostats in heating devices.

Temporary deactivation of the relay

After the heating season, in order to avoid accidental activation of the heating device, the relay in the controller or in the RT receiver may be deactivated.

By simultaneously pressing and holding the  and  buttons for 5 seconds, you can deactivate the relay, deactivate the buttons on the controller, set the temperature to 4°C, and shut down all the elements of the display with the exception of the current temperature, time, and day of the week.

In order to activate all the controller's functions again, press and hold the  and  buttons simultaneously for 5 seconds again.

Replacing batteries

„Low battery" () indicator appears on the LCD if voltage reached its minimum level. Replace batteries as soon as possible.

NOTE: To maintain programmed parameters replace batteries within 30 seconds. We recommend using alkaline batteries to supply AURATON controllers. Rechargeable batteries should not be used because their rated voltage is too low.

NOTE: We recommend using alkaline batteries to supply AURATON controllers. Rechargeable batteries should not be used because their rated voltage is too low.



Cooperation of the RT receiver with a heating device

Basic configuration of devices

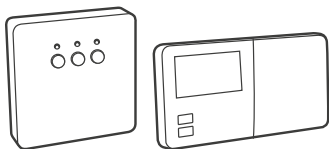

AURATON RT

Receiver connected to the heating device

AURATON R25 RT

Wireless temperature regulator

Additional system devices

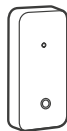

AURATON T-2

Wireless thermometer (sold separately)



AURATON H-1

Window handle (sold separately)

A simplified schematic of connecting the AURATON RT receiver with the heating device

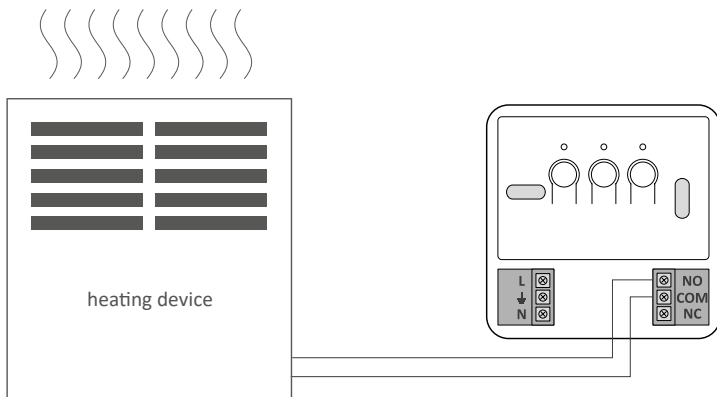

Cooperation of the AURATON RT receiver with the AURATON R25 RT regulator and/or the AURATON T-2 thermometer

The operation of temperature regulation in the receiver is based on the binary algorithm (on/off) using one or two sensor elements.

- The AURATON R25 RT regulator allows for setting and/or monitoring the temperature.
- The AURATON T-2 thermometer provides information about the current temperature only, without the capability of changing it manually.

- A) The manual setpoint – pairing the AURATON R25 RT regulator with the RT receiver allows for setting the temperature manually and controlling it in the location of the fastening of the R25 RT regulator.
- B) The remote setpoint – if the T-2 thermometer is additionally paired with the RT receiver, the AURATON R25 RT regulator retains the capability of temperature setting, however its control is performed with the paired T-2 thermometer only. This feature allows for regulating the temperature in a room other than the one where the AURATON R25 RT regulator is placed.

An example: you want the temperature in the “children’s room” to be always at 22°C, however you do not want children to be able to change it - in that room, you install the T-2 thermometer, and the AURATON R25 RT regulator in e.g. the kitchen. This way the temperature in the “children’s room” will always be at 22°C regardless of temperature fluctuations in the kitchen.

- C) The factory setpoint (20°C) – if the T-2 thermometer is the only device paired with the RT receiver, it is not possible to set the temperature manually, and the RT receiver maintains the factory temperature setpoint of 20°C.

NOTE!

1. The sequence of pairing the AURATON R25 RT regulator and the T-2 thermometer is very important. If you want to maintain the remote setpoint, you must first pair the AURATON R25 RT with the RT receiver, and then the T-2 thermometer. Reversing the pairing sequence will cause automatic deregistering of the previously paired T-2 thermometer and entering the mode of operation described in item A.
2. The RT receiver can operate with one AURATON R25 RT regulator and/or one T-2 thermometer only. Pairing a new regulator causes deregistering the previously paired regulator and the T-2 thermometer. Pairing a new T-2 thermometer causes deregistering the previously paired T-2 thermometer only.
3. The R25 RT regulator and/or the T-2 thermometer can operate with an unlimited number of receivers, e.g. one regulator can simultaneously control two independent heating devices.

Cooperation with the AURATON R25 RT regulator and/or the AURATON T-2 thermometer as well as the AURATON H-1 handles

By default, the AURATON RT receiver does not have any AURATON H-1 handle or AURATON W-1 window position sensor paired, therefore the relay is controlled by the paired AURATON R25 RT regulator and/or the AURATON T-2 thermometer. When at least one H-1 handle is paired with the RT receiver, the relay is controlled in the following manner:

A) The window is closed or trickle-ventilated (micro-ventilation).

When the H-1 window handles is paired with the receiver, and all windows are closed or trickle-ventilated, the relay still maintains the setpoint from the paired AURATON R25 RT regulator and/or the T-2 thermometer.

B) The window is pivoted.

If at least one window is pivoted, the temperature set in the AURATON R25 RT regulator is lowered in AURATON RT receiver down to 3°C. This state will be maintained until closing. This state will last until all windows are closed or trickle-ventilated.

C) The window is opened.

When you open a window equipped with the H-1 handle paired for longer than 30 seconds, the relay in the AURATON RT receiver is switched off, as is the connected heating device. If all the assigned windows are again in a state other than “opened”, the RT receiver returns to normal cooperation with the AURATON R25 RT regulator and/or the T-2 thermometer no earlier than 90 seconds after switching off the relay. The purpose of this delay is to prevent too rapid transitions of the connected heating devices between the ON and OFF states. However, if the temperature in the room drops below 7°C, the relay inside the receiver is switched on regardless of the positions of windows in order to prevent the room from freezing.

D) The signal is lost.

When the RT receiver has lost the signal from the H-1 handle paired (3 consecutive transmissions are lost), it changes the status of this window to “closed”. When the transmission is restored, the H-1 handle is again properly read off by the RT receiver.

RESET of the regulator

Pressing the **RESET button** () causes the time and day setting to be erased, and the regulator to be restarted.

MASTER RESET of the regulator

The MASTER RESET function restarts the regulator and restores factory settings. This function is invoked by pressing the  and RESET buttons simultaneously.

NOTE: All user-defined programs will be erased!

Special situations

- When 3 consecutive transmissions (after 15 minutes) from the AURATON R25 RT regulator and/or the T-2 thermometer are lost, an error is signalled on the RT receiver (LED flashing continuously red and green). The RT receiver starts executing the ON - OFF cycle memorised during the last 24 hours of operation until the problem is removed.
- When both signals return (from the AURATON R25 RT regulator and the T-2 thermometer), the error is cancelled and the receiver enters its normal mode of operation.
- When only the T-2 thermometer signal returns, the receiver uses the last memorised setpoint value and maintains it while signalling the error.
- When the H-1 handles, the T-2 thermometer and the AURATON R25 RT regulator (the temperature is measured with the T-2 thermometer) are paired with the receiver, then maintaining the work cycle from the last 24 hours occurs only after losing the signal from the T-2 thermometer. When only the signal from the AURATON R25 RT is missing, the RT receiver automatically maintains the last memorised setpoint from the AURATON R25 RT regulator and also signals an error.
- When you have only the H-1 handles and the T-2 thermometer paired with the RT receiver without the AURATON R25 RT regulator, the RT receiver maintains a constant, factory-defined temperature of 20°C. If you pivot any window equipped with the H-1 handle paired with the receiver, a temperature of 17°C is maintained. If you open any window equipped with the H-1 handle paired with the RT receiver, the receiver switches off the heating device, but will switch it back on when the temperature falls below 7°C.

Unique features of AURATON R25 RT

- Switching the relay is synchronised with the wave of the 230 V mains voltage in order to ensure that closing and opening contacts of the relay occurs around the zero-crossing point. This prevents the occurrence of an electric arc, significantly extending the relay service time.
- The AURATON RT receiver is equipped with a unique algorithm for analysing the ON - OFF cycles. The entire heating cycle from the last 24 hours is recorded in the memory of the RT receiver. In the event of losing communication with the AURATON R25 RT regulator and/or the T-2 thermometer, the RT receiver automatically executes the ON - OFF cycle memorised during the last 24 hours. This provides time for restoring transmission (removing interferences) or fixing the R25 RT regulator and/or the T-2 thermometer without a significant deterioration of thermal comfort conditions in the controlled spaces.
- The backlit LCD display with the capability of selecting one of three available colours.
- The run time counter of the AURATON R25 RT transmitter.
- Cooperation with optional devices (the AURATON T-2 thermometer, the AURATON H-1 window handle).

Additional information and notes

- The AURATON R25 RT regulator and/or the T-2 thermometer must be installed at least 1 metre from the RT receiver (too strong a signal from the transmitters can cause interference).
- At least 30 seconds must elapse between switching the relay off and on.
- Data transmission from the AURATON R25 RT regulator to the receiver occurs upon each change of 0.2°C of the surrounding temperature. When the temperature is stable, the regulator sends heart-beat data every 5 minutes (which is signalled with the LED blinking orange on the RT receiver).
- In the event of a power outage, the RT receiver will switch off. When power is restored, the heating device is switched on automatically, and the RT receiver awaits a signal from the paired transmitters (this signal should be received within 5 minutes of restoring power). After receiving the signal, the RT receiver enters the normal mode of operation.
- The RT receiver cannot be placed in metal containers (e.g. an assembly box, a metal enclosure of a heater) in order to not to interfere with its operation.

Configuration settings: backlight colour, hysteresis, offset, clock calibration

Configuration settings are presented for changing in the following order:



To enter the configuration settings change mode press the, buttons simultaneously and hold them for 5 seconds until the display backlight starts flashing.

1. BACKLIGHT COLOUR CHANGE

Flashing backlight indicates that you can change the backlight colour with the buttons. Confirm the setting by pressing the button. The regulator will proceed to change the next parameter.

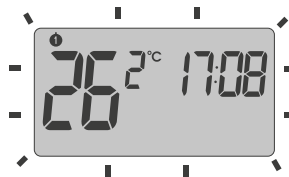

2. HYSTERESIS CHANGE

Hysteresis is designed to prevent switching the controlled device on and off too frequently due to minute fluctuations of temperature.

*E.g. for the **HI2** hysteresis, when the temperature is set to 20°C, the boiler will be switched on at 19.8°C, and switched off at 20.2°C. For the **HI4** hysteresis, when the temperature is set to 20°C, the boiler will be switched on at 19.6°C, and switched off at 20.4°C.*

The hysteresis change mode is signalled by flashing text "HI". You can change hysteresis settings with the buttons.

HI 2 – ±0,2°C (factory setting)

HI 4 – ±0,4°C

HI P – PWM operation mode (see chapter "PWM operation mode").

Confirm the setting by pressing the button. The regulator will proceed to change the next parameter.

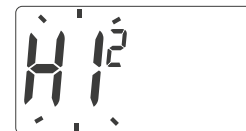

3. OFFSET CHANGE

Offset allows for calibrating temperature indications within the tolerance of ±3°C.

E.g. the temperature regulator indicates that the room temperature is 23°C, whereas a regular mercurial thermometer placed alongside indicates 24°C. Changing offset by +1 degree makes the regulator indicate the same temperature as the mercurial one.

The offset change mode is signalled by flashing text **OFFS**. You can set the desired value within the range from 3.0 to 3.0 (factory setting is 0.0).

Confirm the setting by pressing the button. The regulator will resume normal mode of operation.



4. CLOCK CALIBRATION

This function is used for correcting the clock in case of deviations. When poor operation of the clock is observed during a week, determine the value of incorrect displays. This value, expressed in seconds, should be entered into the controller.

Example 1:

After one week, the controller indicates time accelerated by 1 minute and 20 seconds ($60+20=80$), in which case the clock should be delayed by setting „C -80”.

Example 2:

After one week, the controller indicates time delayed by 2 minutes ($2 \times 60=120$), in which case the clock should be accelerated by setting „C 120”.

NOTE: To calibrate the clock properly, specify the number of seconds after a week of operation of the controller (7 days = number of seconds to be added or subtracted, maximum 294 seconds).

NOTE: If no button is pressed for 10 sec. during the change of configuration settings, then the controller will return to normal operation mode.

PWM operation mode (Pulse-Width Modulation)

By changing the settings of the hysteresis (see chapter “Configuration settings”), you can switch on the PWM operation mode.

In this mode, the controller cyclically switches the heating device on so as to minimize the temperature fluctuations. The controller checks the temperature increase times and the temperature decrease times.

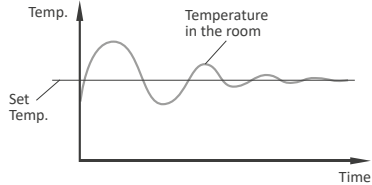

Once these values are known, the controller switches the heating device on and off in cycles that enable keeping the temperature as close as possible to the set value.

NOTE: In the PWM mode, the controller can switch on the heating device even if the temperature in the room is higher than the set temperature. This is due to the PWM algorithm which strives to maintain the set temperature and to anticipate the behavior of the heating system.

The AURATON RT receiver connection schematics

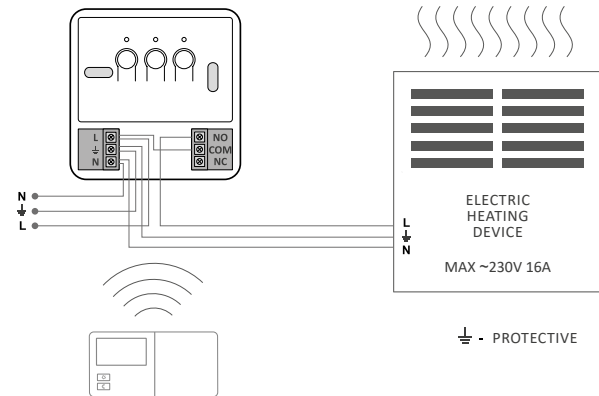
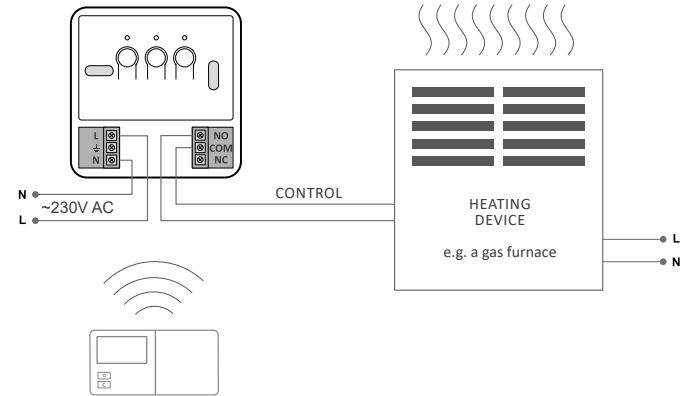

Technical specifications

Working temperature range:	0 – 45°C
Temperature measurement range:	5 – 30°C
Span:	±0,2°C / ±0,4°C / PWM
Temperature levels:	3 + vacation
Antifreeze temperature:	4 – 10°C
Working cycles:	weekly, programmable
Working mode control:	LED (the RT receiver) / LCD (the regulator)
Maximum load:	resistive 16 A inductive / capacitive 10 A
AURATON R25 RT power supply:	2x AA alkaline battery
AURATON RT power supply:	230V AC, 50Hz
AURATON RT radio frequency:	868 MHz
AURATON RT operation range:	in a typical building, with standard construction of walls - approx. 30 m; an open space - up to 300 m

Cleaning and maintenance

- Clean the outside of the device with a dry cloth. Do not use from solvents (such as benzene, thinner or alcohol).
- Do not touch the device with wet hands. It may cause electric shock or serious damage to the device.
- Do not expose the device to excessive smoke or dust.
- Do not touch the screen with a sharp object.
- Avoid contact of the device with liquids or moisture.

Disposing of the devices



The devices are marked with the crossed waste bin symbol. According to European Directive no. 2002/96/EU and the Act concerning used up electric and electronic equipment, such a marking indicates that this equipment may not be placed with other household generated waste.

The user is responsible for delivering the devices to a reception point for used-up electric and electronic equipment.

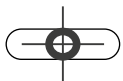

A template for drilling holes for fastening
the AURATON RT receiver (1:1 scale)



A template for drilling holes for fastening
the AURATON R25 RT regulator
(1:1 scale)

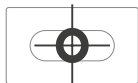



H E A T U N D E R C O N T R O L



www.auraton.pl

ver. 20180706